

MEDIUM VOLTAGE PRODUCT

AdvaSense™ KECA 250 B1

Indoor current sensor

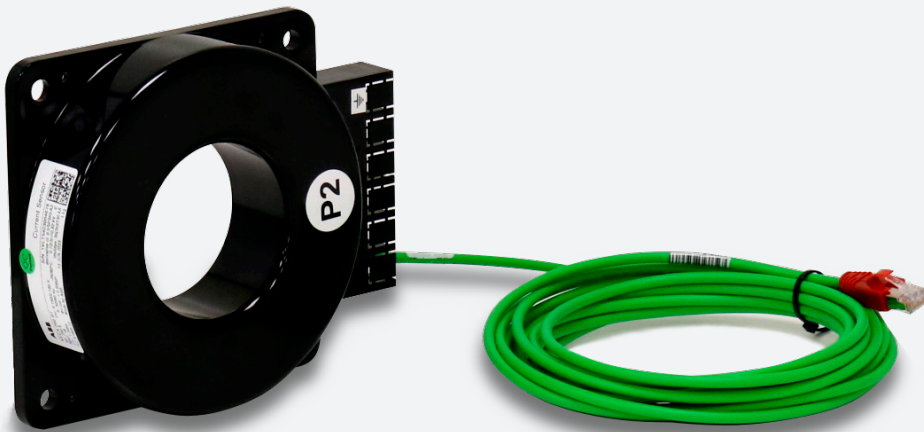

— 01 Sensor characteristics
 — 02 Rogowski coil principle

Parameters for Application	Value
Rated primary current of application	up to 4 000 A

Sensor Parameters	Value
Highest voltage for equipment, U_m	0.72 kV
Rated power frequency withstand voltage	3 kV
Rated primary current, I_{pr}	250 A
Rated continuous thermal current, I_{cth}	IEC 60044-8 2000 A IEC 61869-10 4000 A
Rated transformation ratio, K_{ra}	250 A/ 150 mV at 50 Hz 180 mV at 60 Hz
Current accuracy class	IEC 60044-8 - 0.5/5P125 IEC 61869-10 - 0.5/5P340-A2
Length of cable	5 m

Sensor principles

The AdvaSense™ current sensors (Electronic current transformers according to IEC 60044-8 and low-power passive current transformers according to IEC 61869-10 standards) type KECA 250 B1 offer an alternative way of making the current measurements needed for the protection and monitoring of medium voltage power systems. Sensors based on alternative principles have been introduced as successors to conventional instrument transformers in order to significantly reduce size, increase safety, and to provide greater rating standardization and a wider functionality range. These well known principles can only be fully utilized in combination with versatile electronic relays.

Sensor characteristics

Construction of ABB's AdvaSense™ current sensors is done without the use of a ferromagnetic core. This fact results in several important benefits for the user and the application.

The main benefit is that the behavior of the sensor is not influenced by non-linearity and width of

hysteresis curve, which results in a highly accurate and linear response over a wide dynamic range of measured quantities. A linear and highly accurate sensor characteristic in the full operating range enables the combination of metering and protection classes in one winding. With KECA 250 B1 sensors measuring **class 0.5** is reached for continuous current measurement in the extended accuracy range from 5% of the rated primary current I_{pr} **not only up to 120% of I_{pr}** (as being common for conventional current transformers), **but even up to the rated continuous thermal current I_{cth}** . For dynamic current measurement (protection purposes) the ABB sensors KECA 250 B1 fulfill requirements of protection class **5P up to an impressive value reaching the rated short-time thermal current I_{th}** . That provides the possibility to designate the corresponding accuracy class as **0.5/5P125 (IEC 60044-8) or 0.5/5P340-A2 (IEC 61869-10)**, proving excellent linearity and accuracy measurements.

Current sensor

Current measurement in KECA 250 B1 sensors is based on the Rogowski coil principle. A Rogowski coil is a toroidal coil, without an iron core, placed around the primary conductor in the same way as the secondary winding in a current transformer. However, the output signal from a Rogowski coil is not a current, but a voltage:

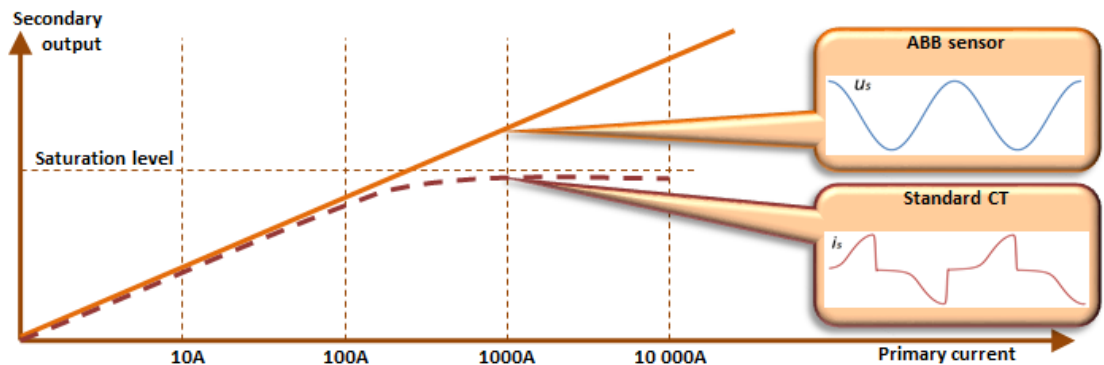
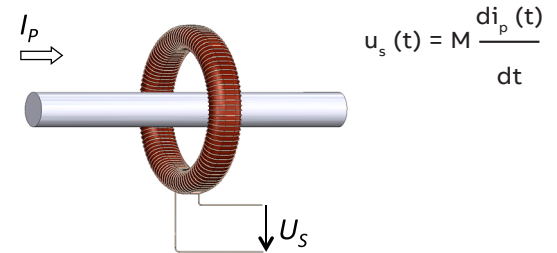

In all cases, a signal that represents the actual primary current waveform is easily obtained by integrating the transmitted output signal.

Protection and control IEDs (Intelligent Electronic Devices)

Protection and control IEDs incorporate the functions of a traditional relay, as well as allow new additional functions. The information transmitted from the sensors to the IED is very accurate, providing the possibility of versatile relay functionality. However, the IED must be able to operate with sufficient accuracy at a sensor’s low input signal level, and the signal from the Rogowski coil must be integrated. Modern IEDs (such as ABB’s 615 series relays) are designed for such sensor use, and they are also equipped with built-in integrators for Rogowski coil sensor inputs. Modern digital apparatuses (microprocessor based relays) allow protection and measurement functions to be combined. They fully support current sensing realized by the single sensor with double the accuracy class designation (e.g.: current sensing with combined accuracy class 0.5/5P125 (IEC 60044- 8) or 0.5/5P340-A2 (IEC 61869-10).



03

Sensor applications

The current sensor type KECA 250 B1 is intended for use in current measurement in low voltage or medium voltage switchgear. In case of medium voltage switchgear the current sensor should be installed over a bushing insulator, insulated cable or any other type of insulated conductor.

Differences between Sensors and Instrument Transformers

There are some noticeable differences between Sensors and conventional Instrument Transformers:

Linearity

Due to the absence of a ferromagnetic core the sensor has a linear response over a very wide primary current range, far exceeding the typical CT range. Thus, current sensing for both measure-

ment and protection purposes could be realized with single secondary winding with a double rating. In addition, one standard sensor can be used for a broad range of rated currents and is also capable of precisely transferring signals containing frequencies different from rated ones.

For this type of sensor, the variation of amplitude and phase error or composite error in a current range from 5% of rated primary current I_{pr} up to the rated short-time thermal current I_{th} is within the limits specified by IEC 61869-10.

Example of current measurement range with rated current 250 A and accuracy class 0.5/5P125 (IEC 60044-8) or 0.5/5P340-A2 (IEC 61869-10):

Metering accuracy class 0.5 is, according to the IEC 60044-8 and IEC 61869-10 standard, guaranteed from 5% of I_{pr} up to $K_{p_{cr}} \times I_{pr}$ where $K_{p_{cr}}$ is rated extended primary current factor and I_{pr} is rated primary current. Factor $K_{p_{cr}}$ is in the case of conventional CTs usually just 1.2, but in the case of the KECA 250 B1 sensor the $K_{p_{cr}}$ factor is several times higher and equals 8. Protection accuracy 5P125 or 5P340-A2 is guaranteed, for the advanced KECA 250 B1 sensor, from the current equal to $K_{p_{cr}} \times I_{pr}$ up to the current corresponding to $K_{aif} \times I_{pr}$ value, where K_{aif} is, according to IEC 60044-8 and IEC 61869-10, the accuracy limit factor. For this type of sensor the value of $K_{p_{cr}} \times I_{pr}$ is equal to the rated continuous thermal current I_{th} and the value of $K_{aif} \times I_{pr}$ is equal to the rated short-time thermal current I_{th} . The accuracy limits are described on the graph.

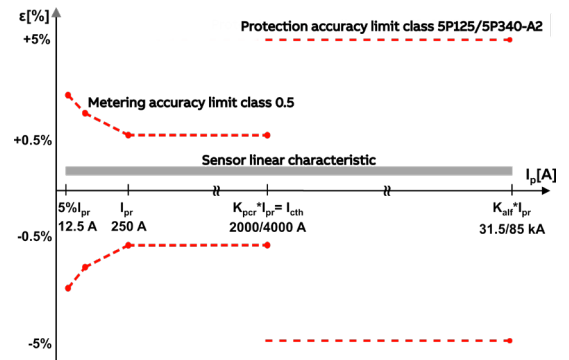

04

Compactness

Since the sensing elements are particularly small, and the same elements are used for both measurement and protection, the current sensors can be easily integrated into other equipment.

—
05 Example of a
sensor labels

—
06 Connector RJ45
(IEC 60044-8)

—
07 Connector RJ45
(IEC 61869-10)

Rated parameters

Because the sensors are highly linear within a very wide range of currents, the same single sensor can be used for the various rated currents associated with each specific application up to the specified maximum voltage for equipment. There is no need to specify other parameters such as burden, safety factor, etc. since they are standard over the defined range. To achieve the correct function of the protection and control IED, the selected rated current, as well as the rated transformation ratio, must be properly set into the IED.

Energy savings concept

As there is no iron core, no necessity for high burden values and thus a possibility for low current losses and only one secondary winding needed, KECA 250 B1 sensors exhibit extremely low energy consumption that is just a fraction of that transferred to heat in conventional CTs. This fact contributes to huge energy savings during its entire operating life, supporting the world-wide effort to reduce energy consumption.

Correction factors

The amplitude and phase error of a current sensor is, in practice, constant and independent of the primary current. Due to this fact it is an inherent and constant property of each sensor and it is not considered as unpredictable and influenced error. Hence, it can be easily corrected in the IED by using appropriate correction factors, stated separately for every sensor.

Values of the correction factors for the amplitude and phase error of a current sensor are mentioned on the sensor label (for more information please refer to Instructions for installation, use and maintenance) and should be uploaded without any modification into the IED before the sensors are put into operation (please check available correction in the IED manual). To achieve required accuracy classes it is recommended to use all correction factors (Cfs): amplitude correction factor (al) and phase error correction factor (pl) of a current sensor.

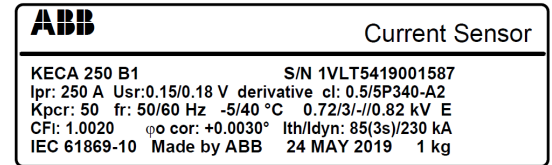
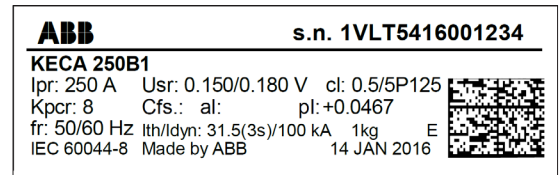

—
05

Secondary cables

The sensor is equipped with a cable for connection with the IED. The cable connector is type RJ45. The sensor accuracy classes are verified up to the RJ45 connector, i.e. considering also its secondary cable. This cable is intended to be connected directly to the IED, and subsequently neither burden calculation nor secondary wiring is needed. Every sensor is therefore accuracy tested when equipped with its own cable and connector.

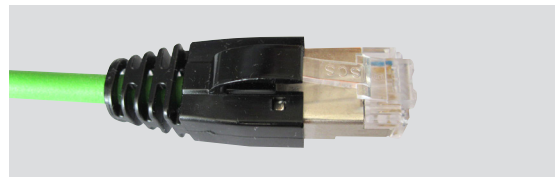

—
06

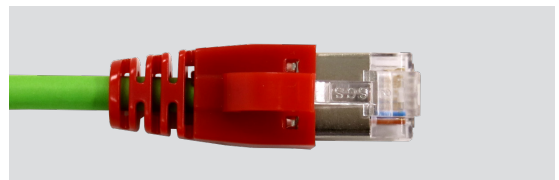

—
07

Standards

IEC 60044-8 (2002-07) Instrument transformers
 Part 8: Electronic current transformers
 IEC 61869-10 (2017-12) Instrument transformers
 Part 10: Additional requirements for low-power
 passive current transformers

Temperature category

- Operation: -5°C/+40°C
- Transport and storage: -40°C/+70°C

Cable

- Length: 5 m
- Connector: RJ-45 (CAT-6)

Dimensions and weight

- Outline drawing number: 1VL5300632R0101
- Weight: 1 kg

Ordering data

- KECA 250 B1(IEC 60044-8) 1VL5400052V0101
- KECA 250 B1(IEC 61869-10) 1VL5400052V1101

	Standard	KECA 250 B1
Highest voltage for equipment and test voltages		
Highest voltage for equipment, U_m	IEC 60044-8 IEC 61869-10	0.72 kV
Power frequency voltage withstand test on primary terminals	IEC 60044-8 IEC 61869-10	3 kV
Insulation requirements for secondary terminals according to IEC 61869-10		
Power frequency voltage withstand capability	IEC 61869-10	0.82 kV
Impulse voltage withstand capability	IEC 61869-10	1.5 kV 1.2/50 μ s
Current sensor, rated values		
Rated primary current, I_{pr}	IEC 60044-8 IEC 61869-10	250 A
Rated transformation ratio, K_{ra}/K_r	IEC 60044-8 IEC 61869-10	250 A/ 150 mV at 50 Hz 180 mV at 60 Hz
Rated secondary output, U_{sr}	IEC 60044-8 IEC 61869-10	3 mV/Hz 150 mV at 50 Hz 180 mV at 60 Hz
Rated continuous thermal current, I_{cth}	IEC 60044-8 IEC 61869-10	up to 2 000 A up to 4 000 A
Rated short-time thermal current, I_{th}	IEC 60044-8 IEC 61869-10	31.5 kA/3s 85 kA/3s
Rated dynamic current, I_{dyn}	IEC 60044-8 IEC 61869-10	100 kA 230 kA
Rated frequency, f_r	IEC 60044-8 IEC 61869-10	50/60 Hz
Rated extended primary current factor, K_{pcr}	IEC 60044-8 IEC 61869-10	8 16
Accuracy limit factor, K_{alf}	IEC 60044-8 IEC 61869-10	125 340
Accuracy class	IEC 60044-8 IEC 61869-10	0.5/5P125 0.5/5P340-A2
Rated burden, R_{br}	IEC 60044-8 IEC 61869-10	10 M Ω 2 M Ω /50 pF

Tab. 1: Current sensor parameters

Dimensional drawing

KECA 250 B1

Outline drawing number: 1VL5300632R0101

Weight: 1 kg

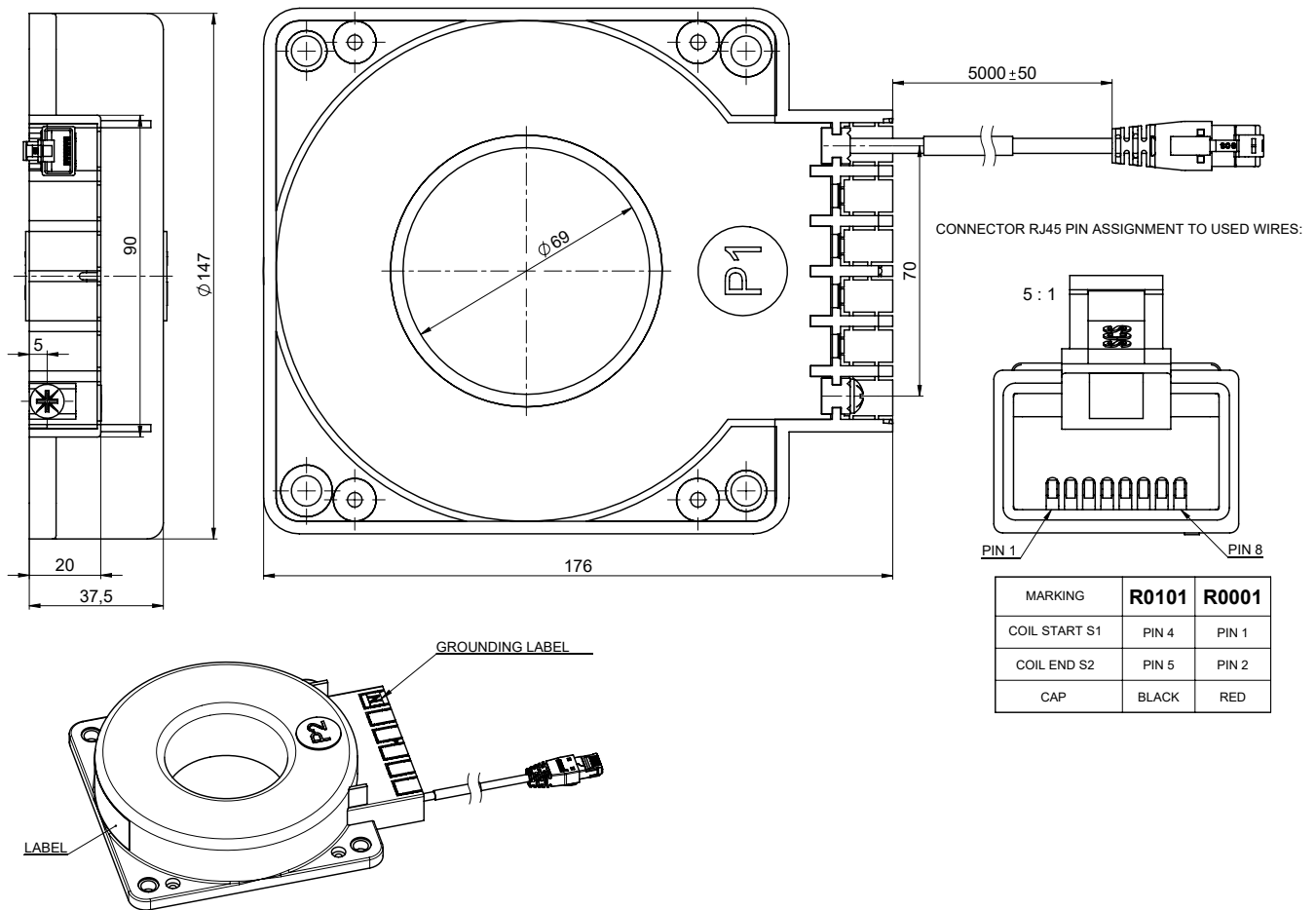

CONTACT US

ABB s.r.o.

ELDS Brno

Videnska 117, 619 00 Brno,
Czech Republic

Tel.: +420 547 152 021

+420 547 152 854

Fax: +420 547 152 626

E-mail: kontakt@cz.abb.com

www.abb.com

NOTE

We reserve the right to make technical changes or modify the contents of this document without prior notice. With regard to purchase orders, the agreed particulars shall prevail. ABB does not accept any responsibility whatsoever for potential errors or possible lack of information in this document.

We reserve all rights in this document and in the subject matter and illustrations contained therein. Any reproduction, disclosure to third parties or utilization of its contents - in whole or in parts - is forbidden without prior written consent of ABB.

Copyright© 2025 ABB
All rights reserved